



GENERAL PUMPS



GBI Series

Bombas mono bloque centrifugas de succión final
End-suction centrifugal monoblock pumps
Centrifugeuse à aspiration finale Pompes monobloc

60 Hz.

www.pumpsgp.com





Construction

The GBI series are non-self priming, horizontal, single-stage, centrifugal, end-suction pumps.

Pumps are available from 3 to 5 HP in single-phase and from 2 to 30 HP in three-phase power supply.

Motor and pump are close coupled in a convenient and compact design for quick installation in limited space.

The pump is fitted with a maintenance-free, mechanical shaft seal and single piece pump-motor shaft.

The pumps have axial suction port and radial discharge port.

Applications

For suitable liquids which are thin, clean, non-explosive, non-aggressive, not containing solid particles or fibers.

For water supply systems and irrigation.

For heating, cooling, air-conditioning and circulation plants.

For civil, industrial and fire fighting applications.

As pressure boosting pump for central water systems with low pressure (follow local specifications if increasing network pressure).

Salient features

Features of the pumps including certain salient ones are listed as below:

- Compact design
- Easy and simple installation
- User-friendly operation
- Low noise level
- Reliable and robust construction
- Back pull-out design which simplifies inspection and maintenance.

Operating conditions

Flow range : Up to 700 USgpm

Head range : Up to 330 feet

Ambient temperature : Max. +122°F

Liquid temperature range: 32°F to +194°F

Total suction lift : Up to 26 feet

Pumped liquids

These pumps are designed for liquids like potable water, rain water or other than thin, clean, non-aggressive, non-explosive, not containing solid particles or fibres.

Sand content

Maximum sand content: 50 g/m³
A higher sand content will reduce the pump life considerably due to wear.

Pump location

The pumps have been designed to operate in a non-aggressive and non-explosive atmosphere.

The relative humidity should not exceed 95%.

Curve conditions

The conditions below apply to the curves shown the following pages.

- Tolerances in accordance with ISO 9906, Annex A.
- The motors used for the measurement are standard motors.
- Test results with clean cold water, without gas content. Measurements have been made with airless water at a temperature of 68°F.
- Head and power values valid for liquids with density $\rho = 1,0 \text{ kg/dm}^3$ and kinematic viscosity $\nu = \text{max } 1 \text{ mm}^2/\text{s}$ (1 cSt).
- The QH curves apply to a rated motor speed of 3450 min⁻¹.
- A safety margin of + 2 feet is recommended for the NPSH value.

Motor

The pump is fitted with a Totally Enclosed Fan Cooled, Cast iron 2-pole induction motor.

Ratings	: 1 phase - 3 to 5 HP 3 phase - 2 to 30 HP
Rated speed	: 3450 rpm
Enclosure class	: IP 55
Insulation class	: F
Standard voltages	: 1 phase, 230 V (Tolerance +5% / -15%) 3 phase, 220/380 V, 230/460 V
Supply frequency	: 60 Hz
Duty / Rating	: S1 / Continuous
Direction of rotation	: Clockwise as seen from the motor rear end.

Three-phase motors must be connected to a motor starter according to local regulations.

Sectional drawing

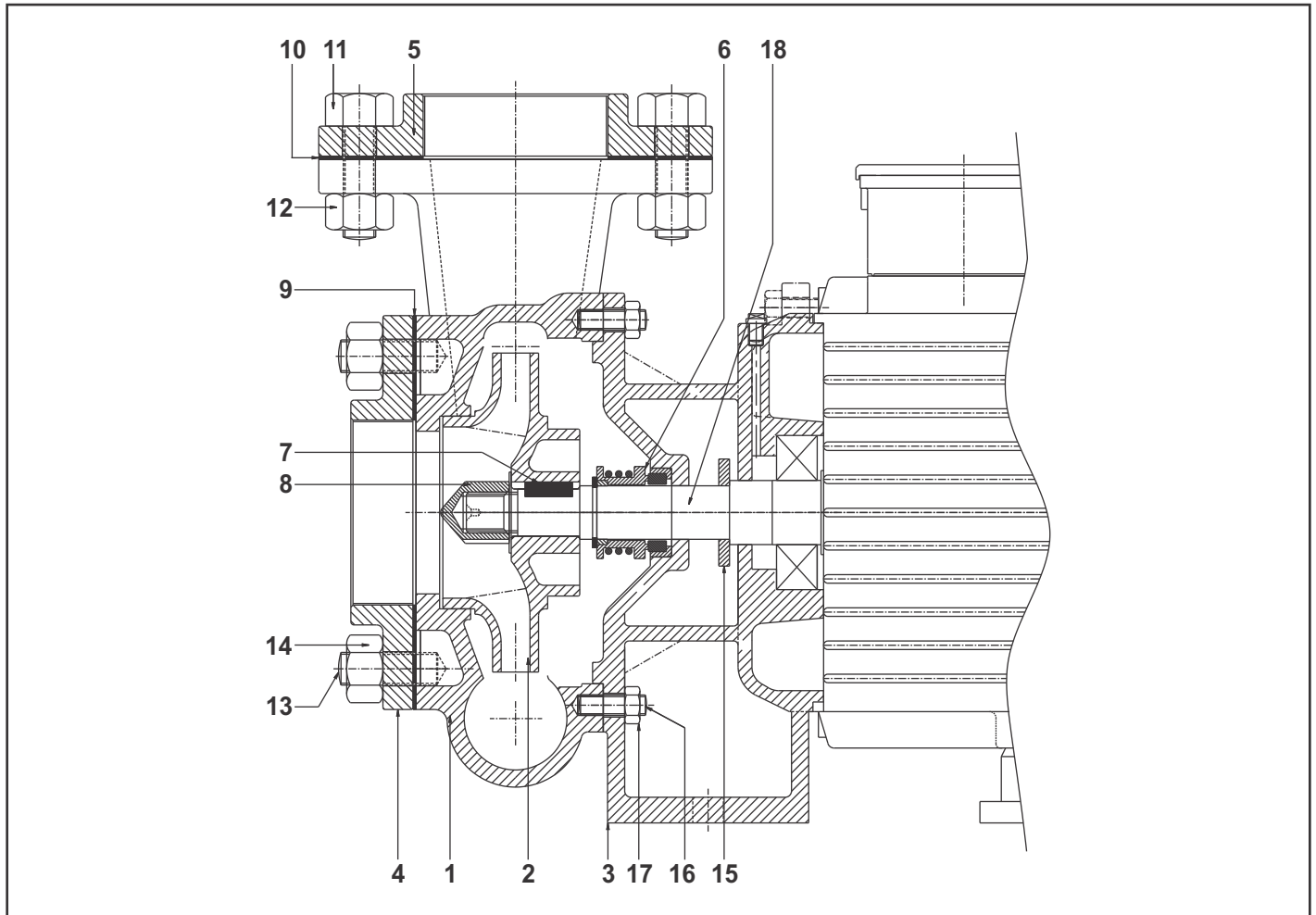

Materials

Pos.	Component	Material
1	Volute	Cast iron
2	Impeller	Cast iron
3	Adaptor	Cast iron
4	Suction flange	Cast iron
5	Delivery flange	Cast iron
6	Mechanical shaft seal	Carbon/Ceramic/NBR
7	Key	Carbon steel
8	Impeller nut	Brass
9	Flange rubber packing (suction)	Rubber
10	Flange rubber packing (delivery)	Rubber
11	Hex bolt	Carbon steel
12	Hex nut	Carbon steel
13	Stud	Carbon steel
14	Hex nut	Carbon steel
15	Water thrower	Rubber
16	Stud	Carbon steel
17	Hex nut	Carbon steel
18	Shaft	Carbon steel*

Note: For Bronze impeller please add a subscript "B" to pump type.

For example: GBI 101 for Cast iron impeller and
GBI 101B for Bronze impeller.

* Stainless steel AISI 410 shaft is available on request.

Characteristic curves

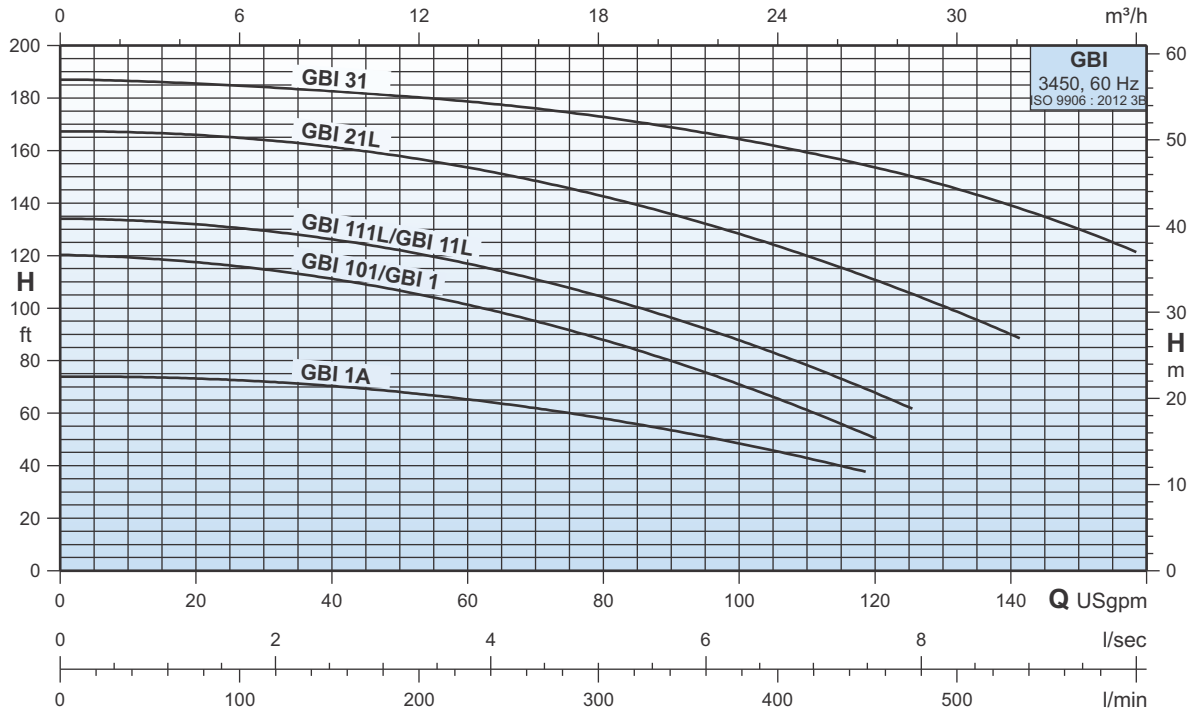

Performance data

Pump type		P ₂		Q l/min	76	151	227	303	379	454	530	568
1 ~	3 ~	HP	kW	Q USgpm	20	40	60	80	100	120	140	150
-	GBI 1A	2	1,5	H ft	73	70	65,5	58	48,5	-	-	-
GBI 101	GBI 1	3	2,2		117,5	111	101	88	70,0	50	-	-
GBI 111L	GBI 11L	5	3,7		132	127	117	104,5	87,5	67,5	-	-
-	GBI 21L	7,5	5,5		165	162	154	142,5	128	111	90	-
-	GBI 31	10	7,5		185	182,5	178	172,5	164	153	139	130

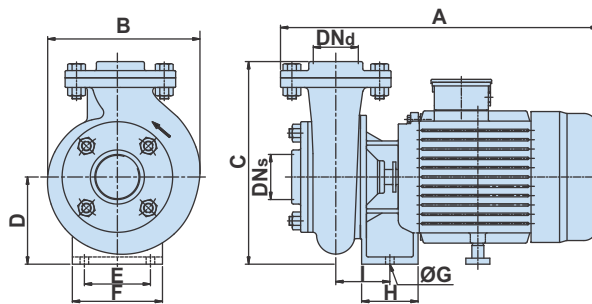

Dimensions and weights

Pump type		P ₂		DN _s	DN _d	Dimensions [inch]									Gross weight [lbs]	Gross volume [ft³]
1 ~	3 ~	HP	kW			A	B	C	D	E	F	ØG	H	I		
-	GBI 1A	2	1,5	2"	2"	16,93	9,84	7,76	4,57	6,30	7,68	0,39	-	5,12	137	4,94
GBI 101	-	3	2,2	2"	1½"	22,44	8,98	12,91	5,71	4,33	5,91	0,55	3,70	3,27	187	5,72
-	GBI 1	3	2,2	2"	1½"	18,11	8,98	12,52	5,31	4,33	5,91	0,55	3,23	3,11	170	5,72
GBI 111L	-	5	3,7	2"	1½"	22,44	8,98	12,91	5,71	4,33	5,91	0,55	3,70	3,27	198	5,72
-	GBI 11L	5	3,7	2"	1½"	19,49	8,98	12,91	5,71	4,33	5,91	0,55	3,70	3,27	194	5,72
-	GBI 21L	7,5	5,5	2"	1½"	21,26	11,38	14,76	6,30	5,75	7,87	0,55	3,98	3,56	256	7,38
-	GBI 31	10	7,5	2"	1½"	22,76	11,38	14,76	6,30	5,75	7,87	0,55	3,98	3,56	265	7,38

Note: All dimensions in inches unless otherwise noted.

Characteristic curves

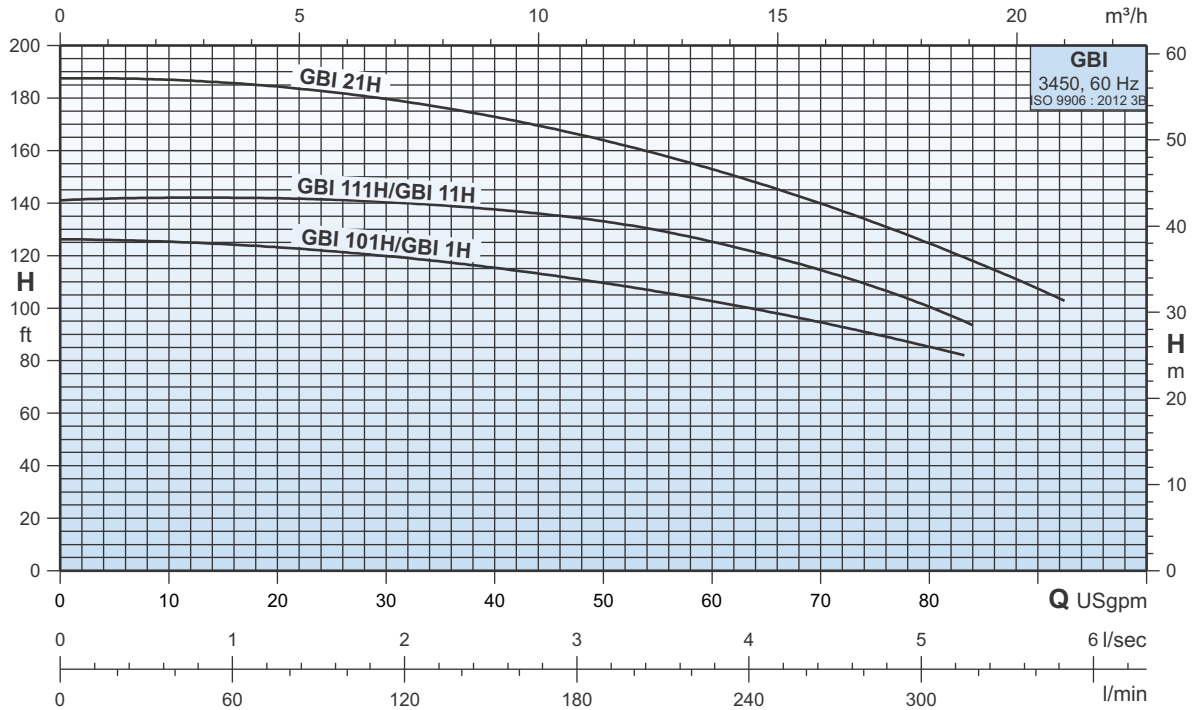

Performance data

Pump type		P ₂		Q l/min	38	76	114	151	189	227	265	303	341
1 ~	3 ~	HP	kW	Q USgpm	10	20	30	40	50	60	70	80	90
GBI 101H	GBI 1H	3	2,2	H ft	125	123	120	115	110	102,5	95	85	-
GBI 111H	GBI 11H	5	3,7		142,5	142	140	137,5	133	125	114,5	100	-
-	GBI 21H	7,5	5,5		187	185	180	172,5	164	153	140	125	107,5

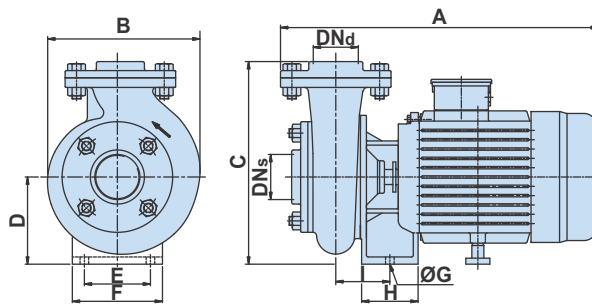

Dimensions and weights

Pump type		P ₂		DN _s	DN _d	Dimensions [inch]									Gross weight [lbs]	Gross volume [ft ³]
1 ~	3 ~	HP	kW			A	B	C	D	E	F	ØG	H	I		
GBI 101H	-	3	2,2	2"	1½"	22,60	9,65	13,50	5,71	5,71	7,48	0,55	3,70	3,43	190	5,72
-	GBI 1H	3	2,2	2"	1½"	18,27	9,65	13,50	5,71	5,71	7,48	0,55	3,35	3,43	172	5,72
GBI 111H	-	5	3,7	2"	1½"	22,60	9,65	13,50	5,71	5,71	7,48	0,55	3,70	3,43	201	5,72
-	GBI 11H	5	3,7	2"	1½"	19,65	9,65	13,50	5,71	5,71	7,48	0,55	3,70	3,43	196	5,72
-	GBI 21H	7,5	5,5	2"	1½"	21,26	11,38	14,76	6,30	5,75	7,87	0,55	3,98	3,56	256	7,38

Note: All dimensions in inches unless otherwise noted.

Characteristic curves

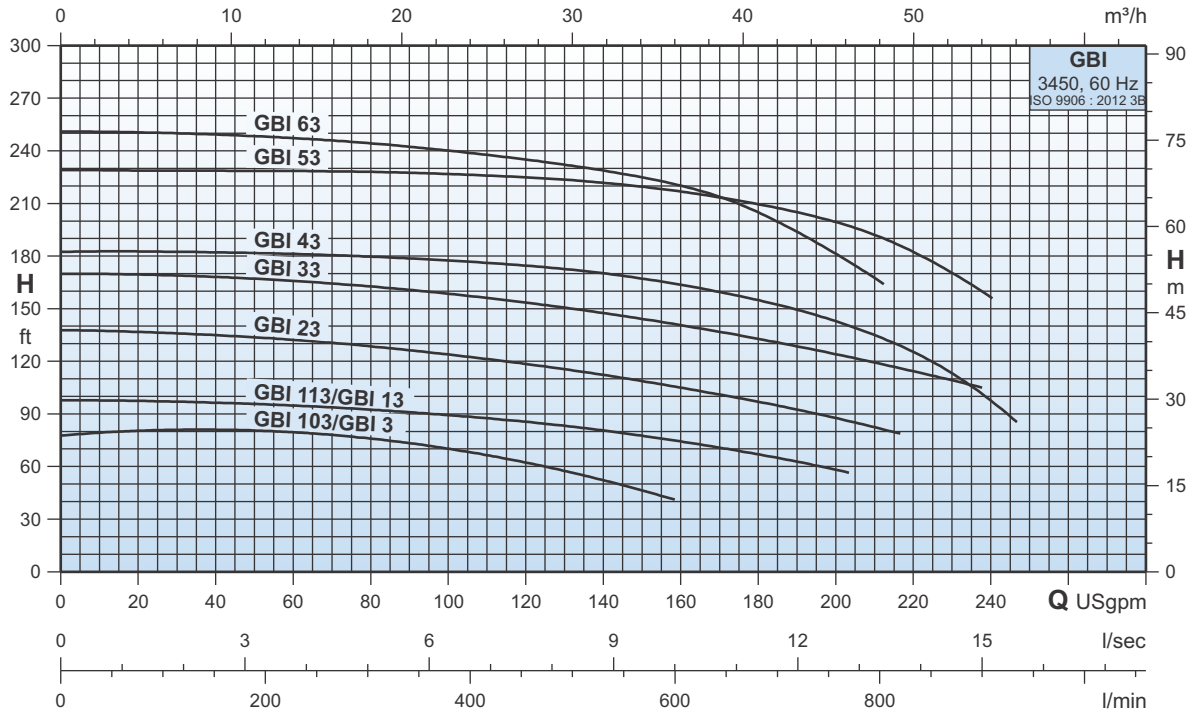

Performance data

Pump type		P ₂		Q l/min	151	227	303	379	454	530	606	681	757	833
1 ~	3 ~	HP	kW	Q USgpm	40	60	80	100	120	140	160	180	200	220
GBI 103	GBI 3	3	2,2	H ft	81	79	76	70	62,5	52,5	-	-	-	-
GBI 113	GBI 13	5	3,7		96	95	93	90	85	80	75	67,5	58	-
-	GBI 23	7,5	5,5		135	133	128	124	118	112	105	97	87,5	-
-	GBI 33	10	7,5		168	166	162,5	158	153	147,5	140	132,5	124,5	115
-	GBI 43	12,5	9,3		187	186	185	182,5	179	174	167	156	142,5	121
-	GBI 53	15	11		233	233	231	228,5	225	220,5	211,5	200,5	188	171,5
-	GBI 63	20	15		254	252	248,5	243	237,5	228,5	216	199,5	174	-

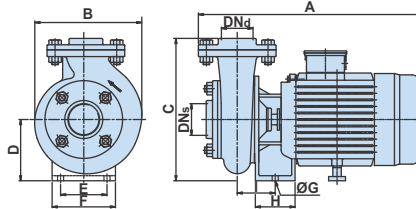

Dimensions and weights

Pump type		P ₂		DN _s	DN _d	Dimensions [inch]									Gross weight [lbs]	Gross volume [ft³]
1 ~	3 ~	HP	kW			A	B	C	D	E	F	ØG	H	I		
GBI 103	-	3	2,2	2½"	2"	22,80	9,21	12,83	5,71	4,33	5,91	0,55	3,70	3,27	192	5,72
-	GBI 3	3	2,2	2½"	2"	18,46	9,21	12,44	5,31	4,33	5,91	0,55	3,35	3,09	174	5,72
GBI 113	-	5	3,7	2½"	2"	22,80	9,21	12,83	5,71	4,33	5,91	0,55	3,70	3,27	203	5,72
-	GBI 13	5	3,7	2½"	2"	19,84	9,21	12,83	5,71	4,33	5,91	0,55	3,70	3,27	198	5,72
-	GBI 23	7,5	5,5	2½"	2"	21,69	10,94	15,35	6,30	5,75	7,87	0,55	3,98	3,68	267	7,38
-	GBI 33	10	7,5	2½"	2"	23,19	10,94	15,35	6,30	5,75	7,87	0,55	3,98	3,68	276	7,38
-	GBI 43	12,5	9,3	2½"	2"	23,11	11,89	15,94	6,89	5,75	7,87	0,55	3,98	3,54	262	7,41
-	GBI 53	15	11	2½"	2"	23,11	11,89	15,94	6,89	5,75	7,87	0,55	3,98	3,54	265	7,41
-	GBI 63	20	15	2½"	2"	26,93	11,89	16,34	7,28	6,10	8,86	0,55	4,65	3,82	442	8,52

Note: All dimensions in inches unless otherwise noted.

Characteristic curves

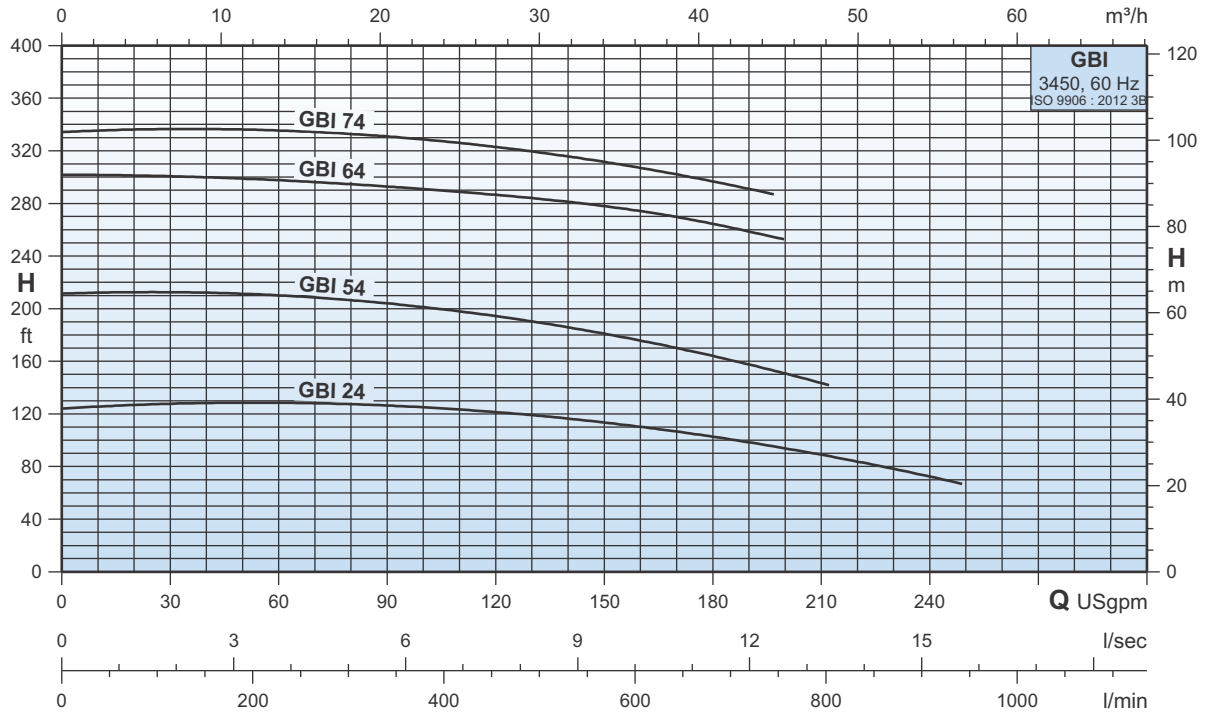

Performance data

Pump type	P ₂		Q l/min	114	227	341	454	568	681	795	908
	HP	kW		Q USgpm	30	60	90	120	150	180	210
GBI 24	7,5	5,5	H	126	125	122	118,5	113,5	106	93	72
GBI 54	15	11		211	209	203,5	195	182	165,5	143	-
GBI 64	20	15		300	298	293	286,5	278	264	-	-
GBI 74	25	18,5		335	333	331	324,5	314	298	-	-

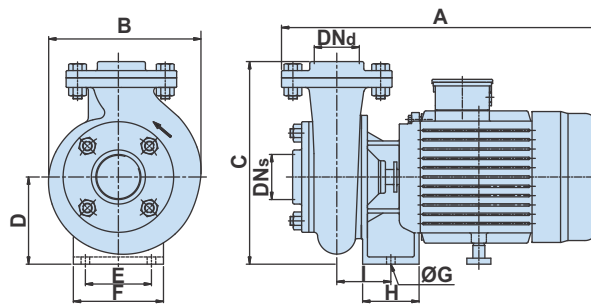

Dimensions and weights

Pump type	P ₂		DN _s	DN _d	Dimensions [inch]									Gross weight [lbs]	Gross volume [ft ³]
	HP	kW			A	B	C	D	E	F	ØG	H	I		
GBI 24	7,5	5,5	2½"	2½"	21,77	9,69	14,80	6,30	5,75	7,87	0,55	3,98	3,54	267	7,38
GBI 54	15	11	2½"	2½"	23,39	13,11	17,32	7,28	8,07	10,24	0,55	3,98	3,66	280	8,44
GBI 64	20	15	2½"	2½"	27,24	13,11	17,32	7,28	8,07	10,24	0,55	4,65	3,94	458	9,55
GBI 74	25	18,5	2½"	2½"	27,24	13,11	17,32	7,28	8,07	10,24	0,55	4,65	3,94	468	9,55

Note: All dimensions in inches unless otherwise noted.

Characteristic curves

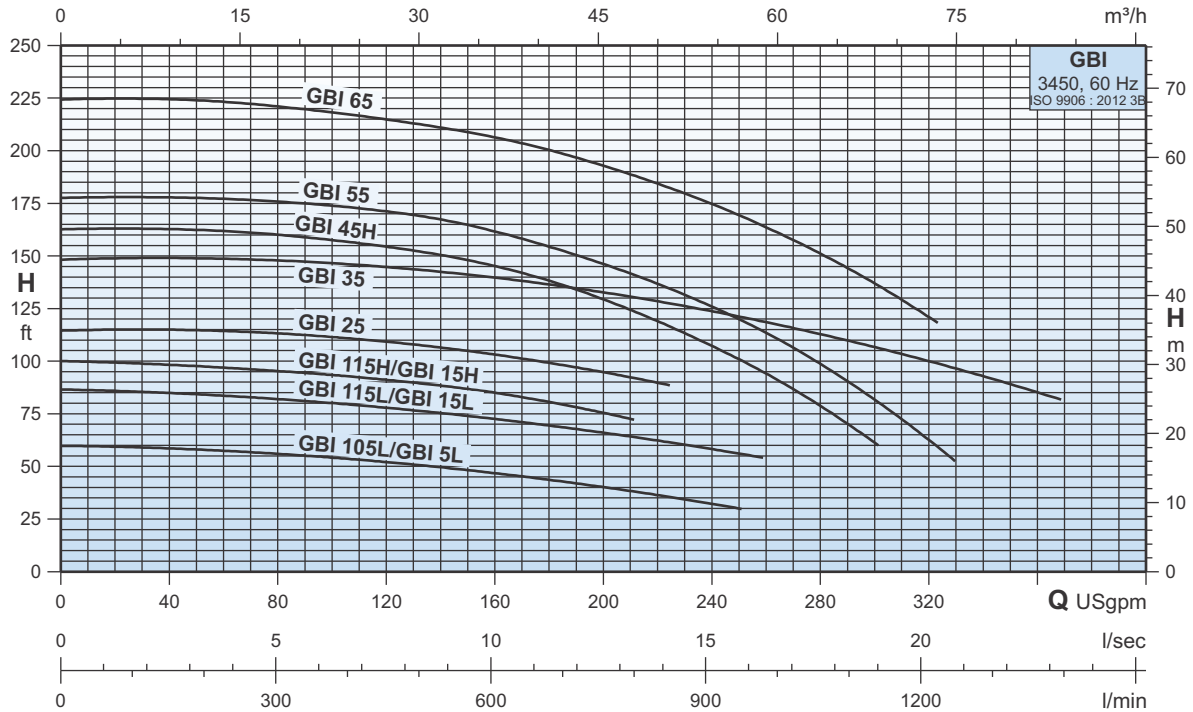

Performance data

Pump type		P ₂		Q l/min	114	227	341	454	568	681	795	908	1136	1325
1 ~	3 ~	HP	kW	Q USgpm	30	60	90	120	150	180	210	240	300	350
GBI 105L	GBI 5L	3	2,2	H ft	59	57,5	55	52,5	48	44	37	32,5	-	-
GBI 115L	GBI 15L	5	3,7		85	83	81	77,5	74	70	65	57	-	-
GBI 115H	GBI 15H	5	3,7		99	97	94,5	91,5	87	80	72,5	-	-	-
-	GBI 25	7,5	5,5		115	114,5	112,5	109,5	105	99	92,5	-	-	-
-	GBI 35	10	7,5		148,5	148	147,5	145	141,5	136,5	131	124	106,5	89
-	GBI 45H	12,5	9,3		163	161,5	158,5	154,5	148	137,5	124	107	61	-
-	GBI 55	15	11		177,5	177	174,5	171	164,5	155	142	126	82	-
-	GBI 65	20	15		225	223,5	220	214,5	209	200	188,5	174	137	-

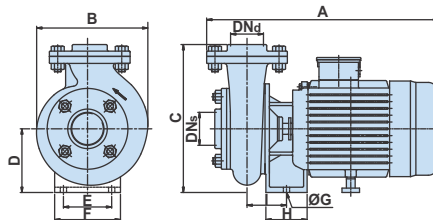

Dimensions and weights

Pump type		P ₂		DN _s	DN _d	Dimensions [inch]									Gross weight [lbs]	Gross volume [ft ³]
1 ~	3 ~	HP	kW			A	B	C	D	E	F	ØG	H	I		
GBI 105L	-	3	2,2	3"	2½"	23,70	10,00	13,39	5,71	4,33	5,91	0,55	3,70	3,54	198	5,72
-	GBI 5L	3	2,2	3"	2½"	19,37	10,00	12,99	5,31	4,33	5,91	0,55	3,31	3,37	187	5,72
GBI 115L	-	5	3,7	3"	2½"	23,70	10,00	13,39	5,71	4,33	5,91	0,55	3,70	3,54	209	5,72
-	GBI 15L	5	3,7	3"	2½"	20,75	10,00	13,39	5,71	4,33	5,91	0,55	3,70	3,54	205	5,72
GBI 115H	-	5	3,7	3"	2½"	23,15	9,41	12,99	5,71	4,33	5,91	0,55	3,70	3,35	209	5,72
-	GBI 15H	5	3,7	3"	2½"	20,20	9,41	12,99	5,71	4,33	5,91	0,55	3,70	3,35	205	5,72
-	GBI 25	7,5	5,5	3"	2½"	21,89	10,59	15,24	6,30	5,75	7,87	0,55	3,98	3,44	267	7,38
-	GBI 35	10	7,5	3"	2½"	23,39	10,59	15,24	6,30	5,75	7,87	0,55	3,98	3,56	276	7,38
-	GBI 45H	12,5	9,3	3"	2½"	23,35	12,24	16,54	6,89	5,75	7,87	0,55	3,98	3,58	262	7,80
-	GBI 55	15	11	3"	2½"	23,35	12,24	16,54	6,89	5,75	7,87	0,55	3,98	3,58	265	7,80
-	GBI 65	20	15	3"	2½"	27,17	12,24	16,93	7,28	6,10	8,86	0,55	4,65	3,82	442	8,96

Note: All dimensions in inches unless otherwise noted.

Characteristic curves

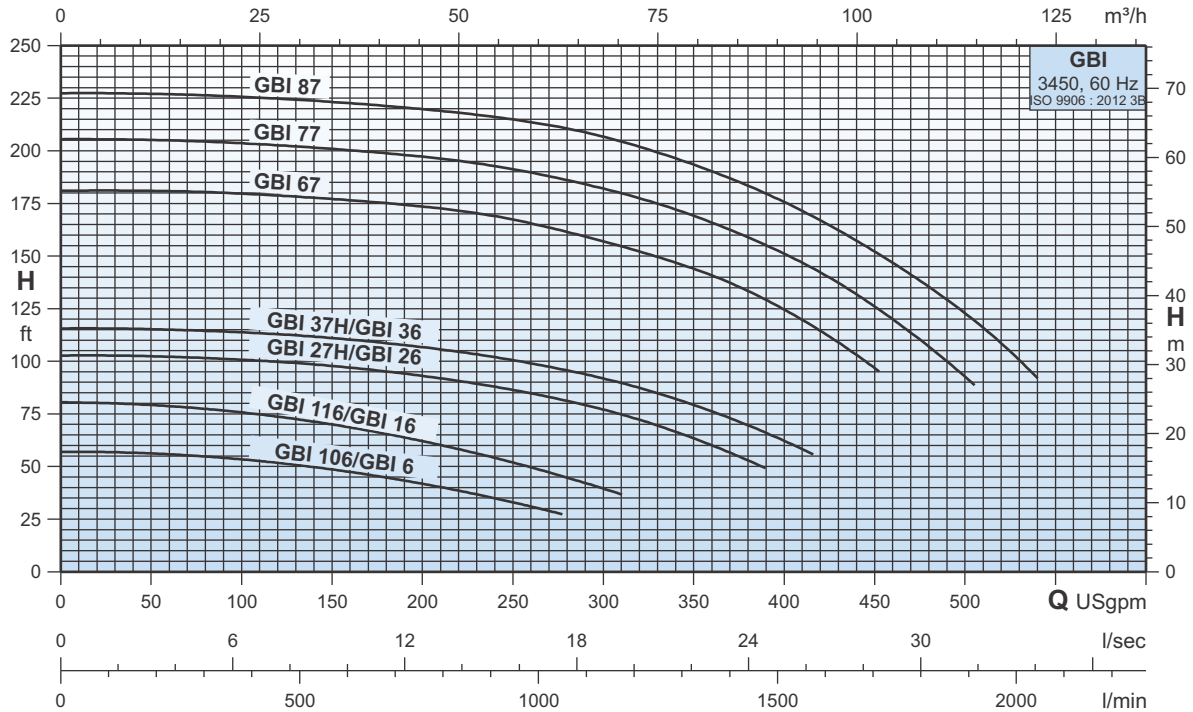

Performance data

Pump type		P ₂		Q l/min	568	757	946	1136	1325	1514	1703	1893
1 ~	3 ~	HP	kW	Q USgpm	150	200	250	300	350	400	450	500
GBI 106	GBI 6	3	2,2	H ft	48,5	42	32,5	-	-	-	-	-
GBI 116	GBI 16	5	3,7		70	62	52	40	-	-	-	-
-	GBI 27H/GBI 26	7,5	5,5		98	93	86,5	77	63,5	-	-	-
-	GBI 37H/GBI 36	10	7,5		111	106,5	100	92	79,5	62,5	-	-
-	GBI 67	20	15		177	173,5	167,5	157	144	125	96,5	-
-	GBI 77	25	18,5		200,5	197	191,5	182	169	151	125,5	93
-	GBI 87	30	22		223,5	219,5	215	207	193,5	175	152,5	122,5

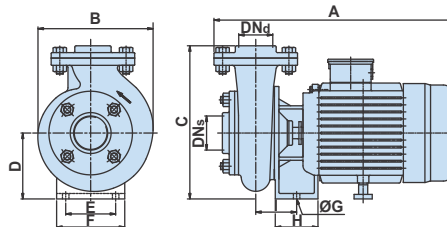

Dimensions and weights

Pump type		P ₂		DN _s	DN _d	Dimensions [inch]									Gross weight [lbs]	Gross volume [ft ³]
1 ~	3 ~	HP	kW			A	B	C	D	E	F	ØG	H	I		
GBI 106	-	3	2,2	3"	3"	23,70	10,00	13,39	5,71	4,33	5,91	0,55	3,70	3,54	201	5,72
-	GBI 6	3	2,2	3"	3"	19,37	10,00	12,99	5,31	4,33	5,91	0,55	3,35	3,37	190	5,72
GBI 116	-	5	3,7	3"	3"	23,70	10,00	13,39	5,71	4,33	5,91	0,55	3,70	3,54	212	5,72
-	GBI 16	5	3,7	3"	3"	20,75	10,00	13,39	5,71	4,33	5,91	0,55	3,70	3,54	207	5,72
-	GBI 27H	7,5	5,5	4"	3"	22,36	10,94	15,39	6,30	5,75	7,87	0,55	3,98	3,72	273	7,38
-	GBI 26	7,5	5,5	3"	3"	22,36	10,94	15,39	6,30	5,75	7,87	0,55	3,98	3,72	273	7,38
-	GBI 37H	10	7,5	4"	3"	23,86	10,94	15,39	6,30	5,75	7,87	0,55	3,98	3,72	282	7,38
-	GBI 36	10	7,5	3"	3"	23,86	10,94	15,39	6,30	5,75	7,87	0,55	3,98	3,72	282	7,38
-	GBI 67	20	15	4"	3"	27,72	12,32	17,60	7,28	6,10	8,86	0,55	4,65	3,94	458	9,38
-	GBI 77	25	18,5	4"	3"	27,72	12,32	17,60	7,28	6,10	8,86	0,55	4,65	3,94	468	9,38
-	GBI 87	30	22	4"	3"	27,72	12,32	17,60	7,28	6,10	8,86	0,55	4,65	3,94	474	9,38

Note: All dimensions in inches unless otherwise noted.

Characteristic curves

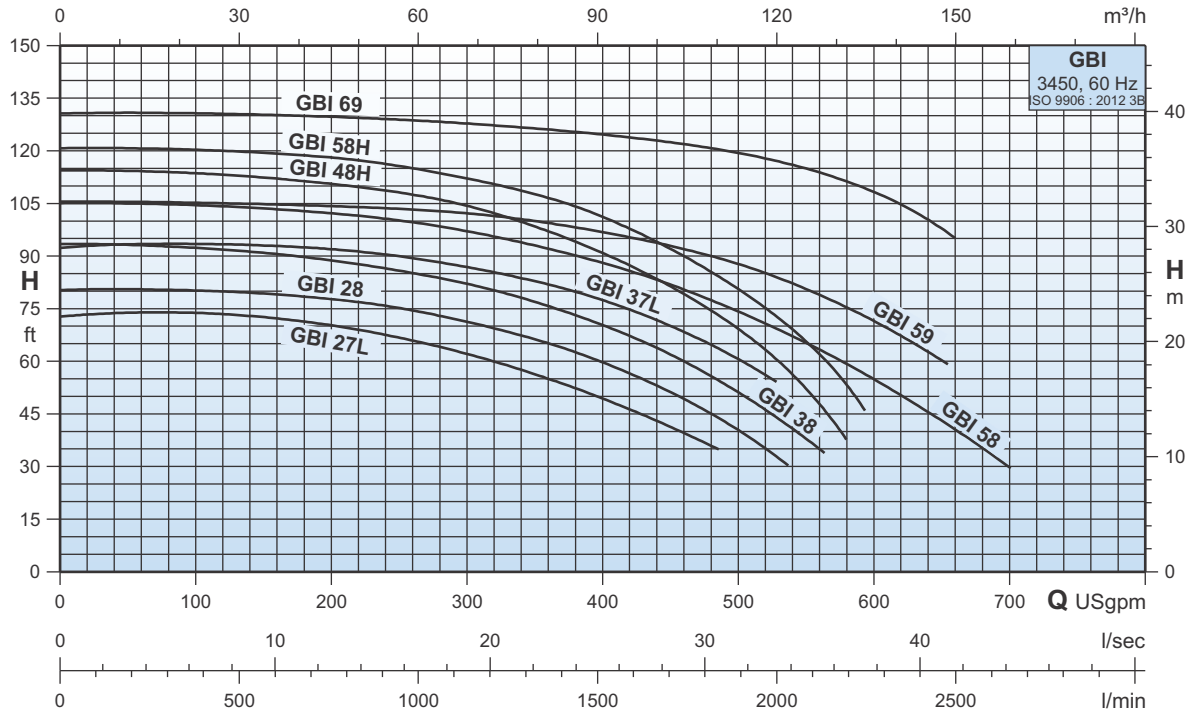

Performance data

Pump type	P ₂		Q l/min	379	757	1136	1514	1893	2271	2650	
	HP	kW		Q USgpm	100	200	300	400	500	600	700
3 ~			H ft								
GBI 27L	7,5	5,5		74	70	62	49,5	-	-	-	-
GBI 28	7,5	5,5		80	77,5	71	59,5	40,5	-	-	-
GBI 37L	10	7,5		93,5	92,5	87	77,5	60	-	-	-
GBI 38	10	7,5		92	89	82	70	51,5	-	-	-
GBI 48H	12,5	9,3		113,5	110	104,5	91	69,5	-	-	-
GBI 58	15	11		104	102	92	88	74,5	55	30	-
GBI 58H	15	11		120	118	112,5	101	80,5	-	-	-
GBI 59	15	11		105	104	102	96,5	88	72	-	-
GBI 69	20	15		130,5	129,5	127,5	124,5	119	108,5	-	-

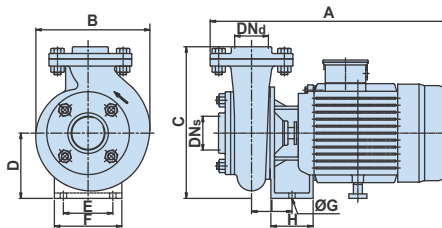

Dimensions and weights

Pump type	P ₂		DN _s	DN _d	Dimensions [inch]									Gross weight [lbs]	Gross volume [ft³]
	HP	kW			A	B	C	D	E	F	ØG	H	I		
GBI 27L	7,5	5,5	4"	3"	22,36	10,94	15,39	6,30	5,75	7,87	0,55	3,98	3,74	273	7,38
GBI 28	7,5	5,5	4"	4"	24,80	10,75	15,59	6,30	5,75	7,87	0,55	3,98	4,06	280	7,38
GBI 37L	10	7,5	4"	3"	23,86	10,94	15,39	6,30	5,75	7,87	0,55	3,98	3,74	282	7,38
GBI 38	10	7,5	4"	4"	23,86	10,75	15,59	6,30	5,75	7,87	0,55	3,98	4,06	289	7,38
GBI 48H	12,5	9,3	4"	4"	24,76	11,06	16,85	6,89	5,75	7,87	0,55	3,98	4,02	278	7,74
GBI 58	15	11	4"	4"	24,84	12,99	16,73	6,89	5,75	7,87	0,55	3,98	3,94	331	8,83
GBI 58H	15	11	4"	4"	24,76	11,06	16,85	6,89	5,75	7,87	0,55	3,98	4,02	283	7,74
GBI 59	15	11	5"	5"	25,59	11,73	18,23	6,89	5,75	8,86	0,55	3,98	4,06	288	8,71
GBI 69	20	15	5"	5"	29,53	11,73	18,62	7,28	6,10	8,86	0,55	4,65	4,29	466	9,94

Note: All dimensions in inches unless otherwise noted.







GENERAL PUMPS



FOR MORE DETAILS
SCAN THE QR CODE

CONTACT US

GENERAL PUMPS, S.L.U.

-  Pol. Ind. El Oliveral (U.E.7, Nave nº1) - Calle W 46394 Ribarroja del Turia - Valencia Spain
-  Tel. : +34 96 1665200 / Fax :+34 96 1665052
-  E-mail: info@pumpsgp.com
-  www.pumpsgp.com